

# LESSO

## SOLAR MOUNTING SYSTEM BRACKET



**Lesso New Energy Global Trading Private Limited**

One Raffles Quay, North Tower, #19-03, Singapore 048583

LESSO Group (2128) is listed in the Stock Exchange of Hong Kong.

 [www.lessosolar.com](http://www.lessosolar.com)  [info@lessosolar.com](mailto:info@lessosolar.com)     LESSO Solar



## PRODUCTION OVERVIEW



Solar Mountings & Accessories

### Production Workshop

Covering an area of approximately 10,000m<sup>2</sup>, the production workshop is equipped with multiple advanced devices including JCH roll forming machines, U-channel steel production lines, cold roll forming machines, slitting machines, combined punching and cutting machines, C-type single-point precision punching machines, crawler cranes and high-altitude roll forming machines.

Floor Area: **10,000m<sup>2</sup>**



### Mold Workshop

Covering an area of approximately 8,880m<sup>2</sup>, the mold workshop is equipped with a variety of CNC machining centers, including horizontal machining centers and gantry type machining centers, CNC devices including CNC lathes, EDM forming machines, pneumatic punching machines, wire rope cutting machines, CNC double milling machines, injection molding machines, composite grinding machines, center-less grinding machines and CNC engraving machines, as well as 83 general-purpose processing devices including lathes, drilling machines, milling machines and grinding machines.

Floor Area: **8,880m<sup>2</sup>** Processing devices: **83sets**



## PRODUCTION EQUIPMENT



○ U-channel steel production line



○ High-altitude roll forming vehicle



○ Combined punching and cutting machine for aluminum parts



○ Laser cutting machine



○ JCH roll forming machine



○ Automatic welding machine



○ C-type single-point precision punching machine



# CONTENT

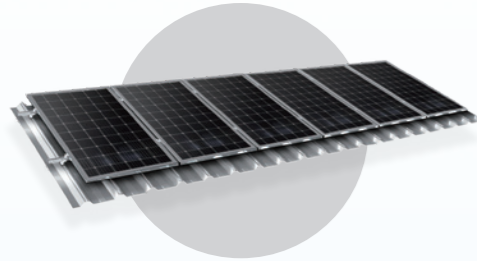

**05/06**  
**Solar Mounting System for Color Steel Tile Roof**



**07/08**  
**Solar Mounting System for Concrete Roof**

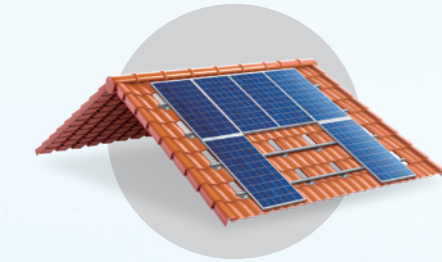

**09/10**  
**Solar Mounting System for Glazed Tile Roof**



**11/12**  
**Solar Mounting System for  
Agriculture and Aquaculture Farm**

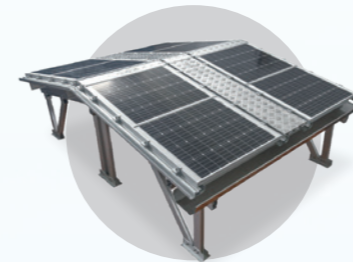

**13/14**  
**BIPV Water-proof Solar Mounting**





# Solar Mounting System for Color Steel Tile Roof

## [LS001]



### Introduction

The solar mounting system for color steel tile roof is suitable for distributed power stations. It consists of aluminum profiles making it very light, with low loading requirements for the roof.

### Features

- All-aluminum structure, light weight, reduced roof load, simple, reliable and durable.
- Suitable for photovoltaic power stations on large area color steel tile roofs for facilities or warehouses.
- Multiple clamps available for different types of color steel tile panels.
- Fully universal superstructure and components.
- Unique lightning-proof grounded design, reducing the cost of additional lightning-proofing.

### Product Description

Installation Location	Snow Load	Material	Service Life
Color Steel Tile Roof	70kg/m <sup>2</sup>	Aluminum Profile	25 Years
Drawing Force	Wind-bearing Capacity	Mounting Type	Color
1000N	40m/s, 32.5kg/m <sup>2</sup> , level 13	Frame	Natural Color

### Main Components



### Installation Step

#### Step 01.

Fix the clamp on the color steel tile using hexagonal bolts, fix the guide rail to the clamp, and connect the guide rails using the connectors.

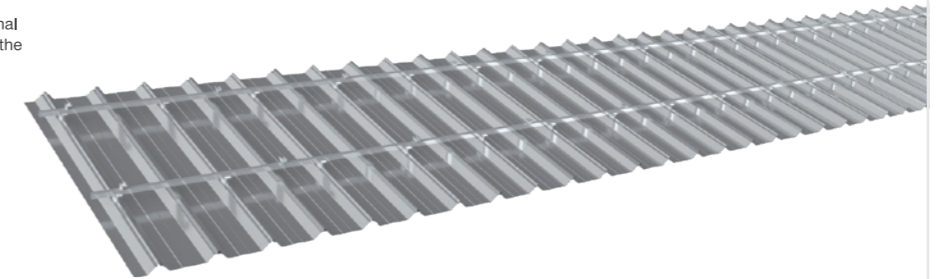

#### Step 02.

Fix the PV modules to the guide rails using the hexagonal bolts, edge pressure blocks, middle pressure blocks, and spring washers.



### Installation Node Diagram

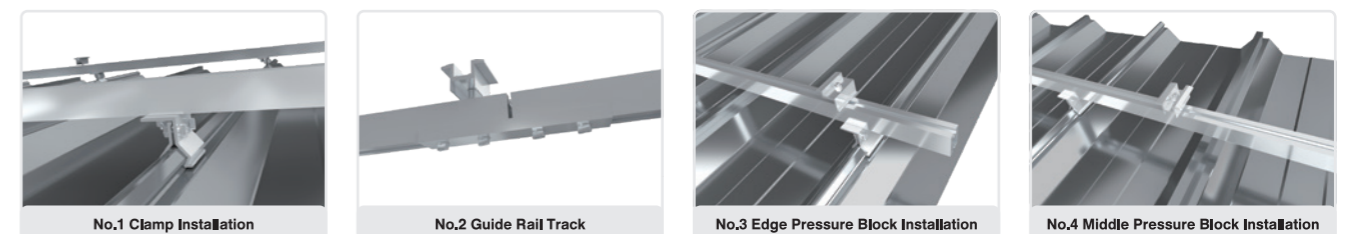



# Solar Mounting System for Concrete Roof

[LS002]



## Introduction

The solar mounting system for concrete roof is suitable for solar power stations installed on the ground or on concrete roofs. It features good wind resistance and is highly cost effective, and able to meet most customer demands.

## Features

- Light weight, solid structure, reducing roof loads.
- Prefabricated concrete roof, simplifying installation procedures and reducing working hours on site, with no damage to the original building structure.
- Designed with mounting at an incline, guaranteeing higher power output.
- Unique lightning-proof grounded design, reducing the cost of additional lightning-proofing.

## Product Description

Installation Location	Snow Load	Material	Service Life
Flat Ground/ Roof	14KN/m <sup>2</sup>	Carbon Steel	25 Years
Drawing Force	Wind-bearing Capacity	Surface Treatment	
1000N	40m/s	Hot-dip Galvanizing/ Aluminum-Zinc-Magnesium Alloy Coating	
Specification of PV Modules	PV Module Layout	Inclination Angle of Modules	
All Specifications Supported	Horizontal/Vertical	As per customer requirements	

## Main Components

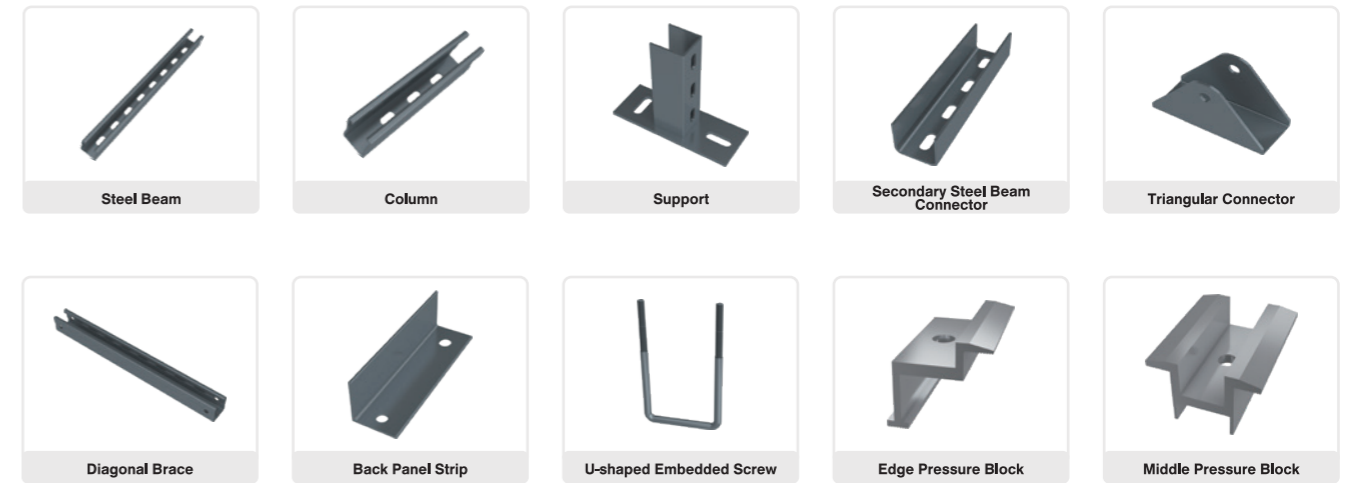

## Installation

### Step 01.

Fix the support to the cement base, then connect the column and support.

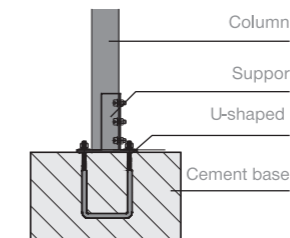

### Step 02.

Fix the diagonal brace onto the column and steel beam using the triangular connector.

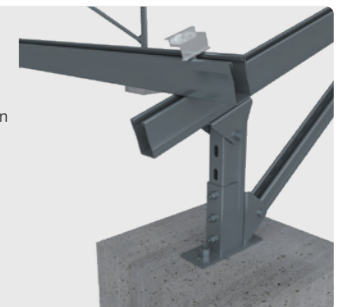

### Step 03.

Fix the PV modules onto the steel beam using the edge and middle pressure blocks.



## Installation Node Diagram

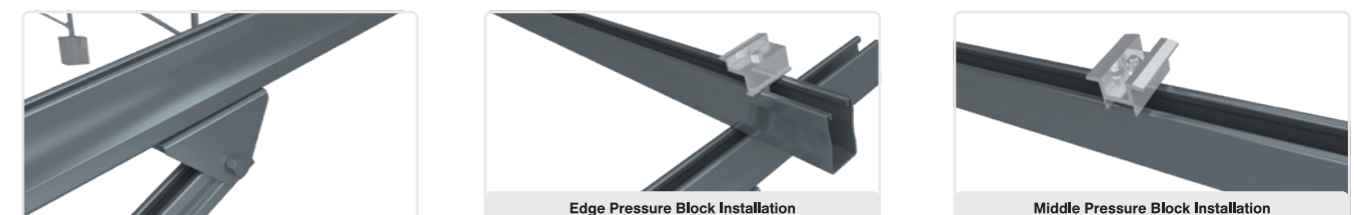



# Solar Mounting System for Glazed Tile Roof

[LS003]



## Introduction

The solar mounting system for glazed tile roof is suitable for distributed power stations. It features stainless steel hooks and aluminum profiles for strong adaptability to different types of glazed tile roofs and low loading requirements.

## Features

- Suitable for a variety of conventional glazed tile roofs and tile types of different heights, easily adjustable mounting and convenient installation.
- Materials with different specifications can be selected as the main bearing parts according to specific loads, ensuring structural safety and effective control over mounting costs.
- Stainless steel and anodized aluminum alloy materials ensure an aesthetic appearance and outstanding anti-corrosion performance.

## Product Description

Installation Location	Snow Load	Material	Service Life
Glazed Tile Roof	70kg/m <sup>2</sup>	Aluminium Profile	25 Years
Drawing Force	Wind-bearing Capacity	Mounting Type	Color
1000N	40m/s, 32.5kg/m <sup>2</sup> , level 13	Frame	Natural Color

## Main Components



## Installation

### Step 01.

Fix the curved hook to the wooden beam, then secure the guide rail to the hook.

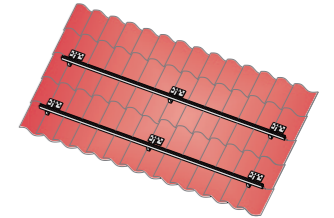

### Step 02.

Fix the PV modules to the guide rail using the middle and edge pressure blocks.

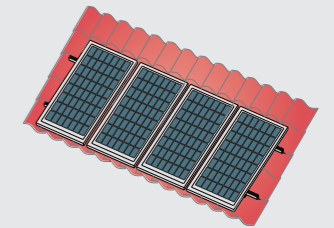

## Installation Node Diagram

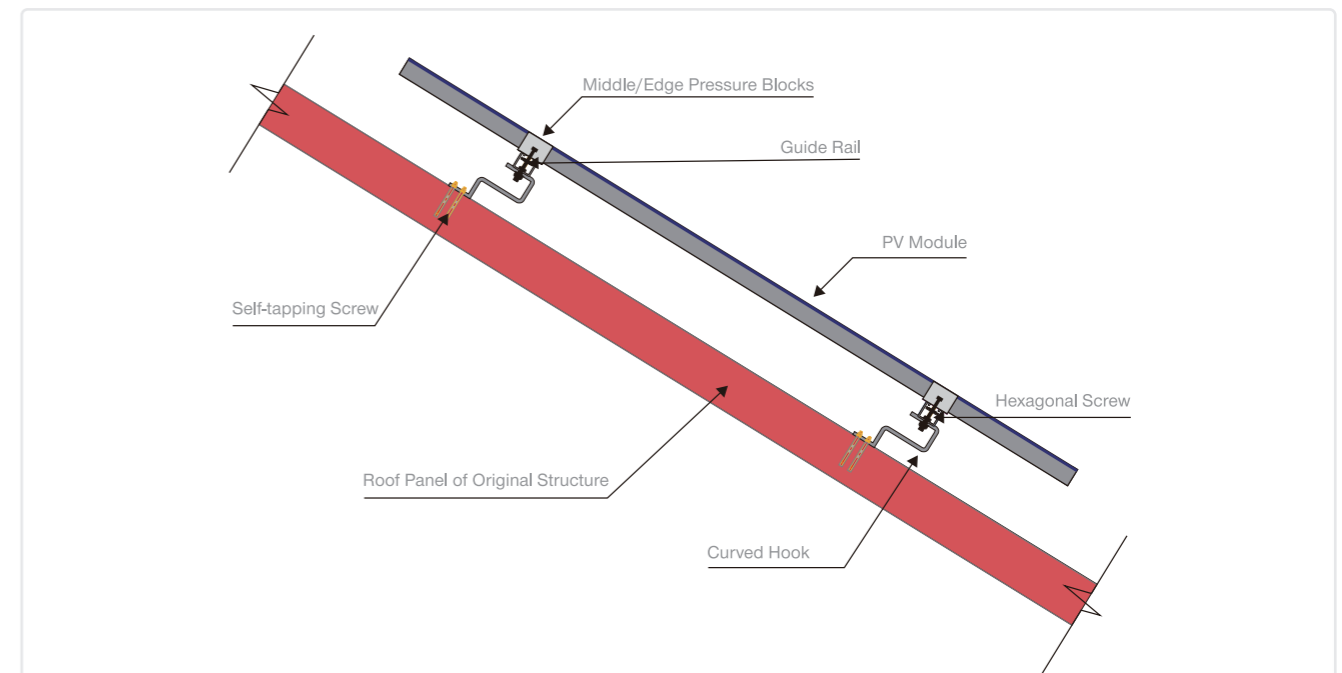



# Solar Mounting System for Agriculture and Aquaculture Farm

## [LS004]



### Introduction

The single column solar mounting system is suitable for solar power stations for agriculture and aquaculture farms and large mountain solar power stations. It has low requirements in terms of terrain, strong adaptability to a variety of complex environments, and convenient installation, meeting most customer demands.

### Features

- Single column structure, small footprint.
- One piece of land for multiple uses: generating power and raising fish (growing vegetables), greatly increasing the utilization efficiency of land resources.
- Prestressed concrete pile foundation - mounting height can be adjusted according to water depth and crop growth.
- Prestressed concrete piles are highly corrosion-resistant against acidic soil containing chemical fertilizers and against long-term water soaking.

### Product Description

Installation Location	Snow Load	Material	Service Life
Fish ponds or ground-based	0.5KN/m <sup>2</sup>	Carbon Steel	25 Years
Drawing Force	Wind-bearing Capacity	Surface Treatment	
1000N	40m/s	Hot-dip Galvanizing/ Aluminum-Zinc-Magnesium Alloy Coating	
Specification of PV Modules	PV Module Layout	Inclination Angle of Modules	
All Specifications Supported	Horizontal/Vertical	As per customer requirements	

### Main Components

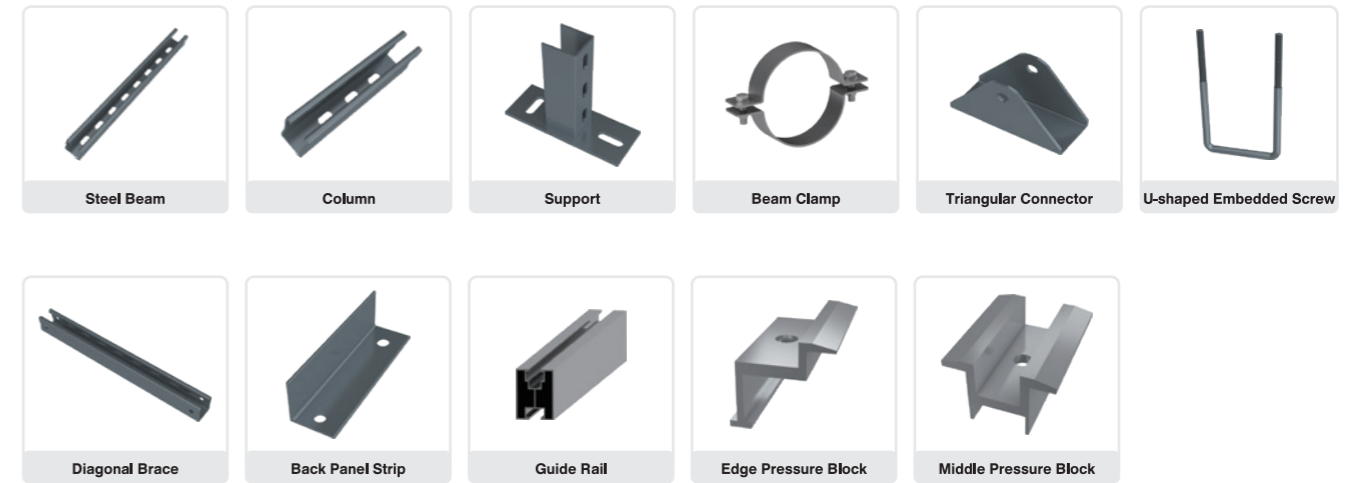

### Installation

- Pre-embed the U-bolts on the pipe piles.
- Fix the support and column to the pipe pile.
- Install steel beam and guide rail.
- Install beam clamp, and connect diagonal brace, steel beam and hoop using the triangular connector;
- Install the PV modules on the guide rail using the edge and middle pressure blocks.

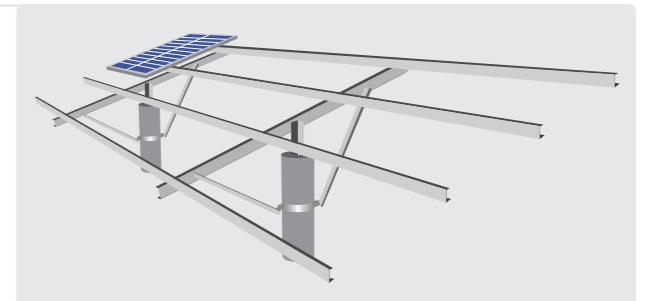

### Installation Node Diagram

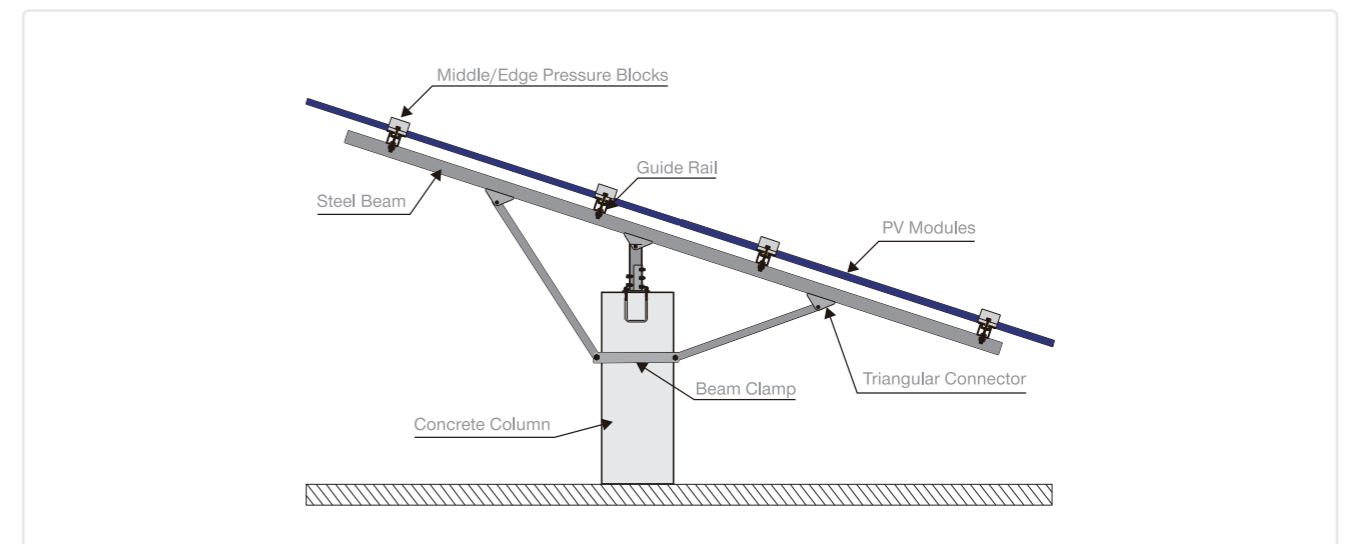



# BIPV Water-proof Solar Mounting

[LS005]



## Introduction

The BIPV mounting is suitable for sun rooms with concrete roofs, BIPV commercial plants, and waterproof PV carports.

## Features

- Solid structure, strong corrosion resistance.
- Convenient installation, reducing labor costs.
- Lap-type component installation, with multiple forms of protection for outstanding waterproofing performance.
- Intelligent use of space, meeting client requirements

## Product Description

Installation Location	Material	Service Life
Plants, Carports and Sun Rooms	Zinc-Aluminum-Magnesium, Aluminum Alloy, Stainless Steel	25 Years
Snow Load	Wind-bearing Capacity	Installation Angle
As per project requirements	As per project requirements	As per project requirements
PV Module Layout	Specification of PV Modules	
Horizontal/Vertical	All Specifications Supported	

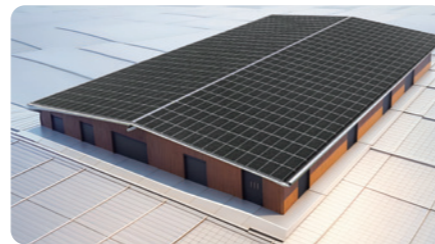

BIPV Plant



Waterproof PV carport



BIPV sun room

## Main Components

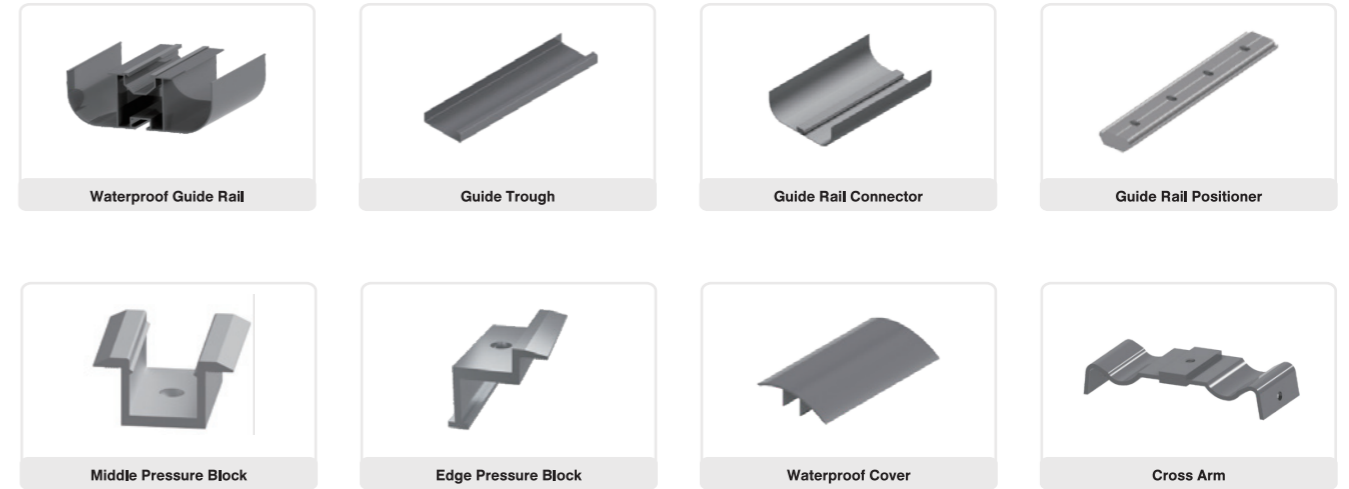

## Installation

### Step 01.

Install the waterproof guide rail (main trough) onto the paved horizontal cross-beam using the M8\*25 T-screw set.

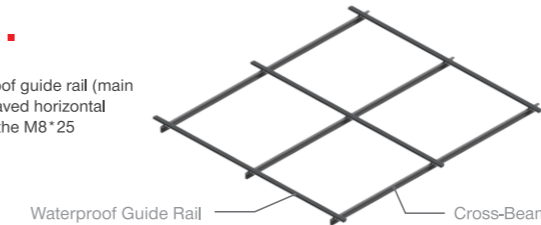

Installation Node Diagram of Waterproof Guide Rail and Cross-Beam:

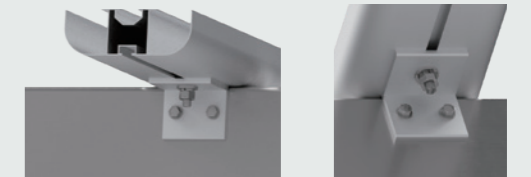

### Step 02.

Install the PV modules onto the waterproof guide rail from top to bottom and from left to right. Before installing the side press and center press, first complete the installation of the guide trough under the PV modules. (Note: When fitting the components horizontally, a weather-resistant sealant needs to be inserted into the gap between the upper and lower components for added strengthening and waterproofing, and to reduce water ingress. In addition, vertical supports should be added to the lower middle section of the components, in order to prevent sinking and cracking).



Installation Node Diagram of PV Modules:

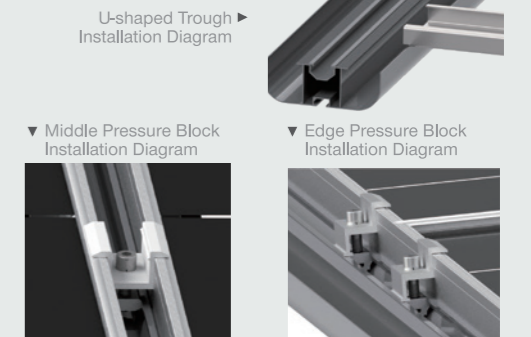

### Step 03.

Install waterproof cover in the middle gap between the PV modules. Press down directly or use a rubber mallet to clamp them tightly to the middle pressure block.

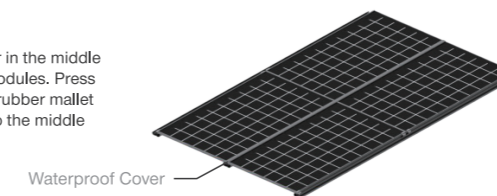

Installation Node Diagram of Waterproof Cover:

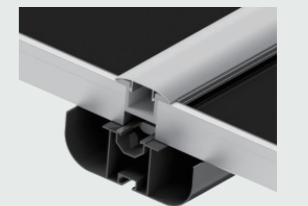





Project Capacity

**600MW**

# Karamay Desert Solar Power Station

Location: Karamay, Xinjiang, China



## Ningxiang Rooftop Solar Power Station

Location: Changsha, Hunan, China  
Project Capacity: 9.75MW



## Dingan Rooftop Solar Power Station

Location: Dingcheng, Dingan, Hainan, China  
Project Capacity: 6MW



## Ducheng Roof Solar Power Station

Location: Yunan, Yunfu, China  
Project Capacity: 5MW



## Our Choice Mall Rooftop Solar Power Station

Location: Longjiang, Shunde, Guangdong, China  
Project Capacity: 167KW



## Huihuang Wear Resistant Factory Rooftop Solar Power Station

Location: Liuzhou, Guangxi, China  
Project Capacity: 542KW



## Tianming New Energy Rooftop Solar Power Station

Location: Shunde, Foshan, Guangdong, China  
Project Capacity: 432KW



# STRATEGIC PARTNERS

LESSO 联塑班皓



CGE 中绿能集团

